

POTION EXPLOSION

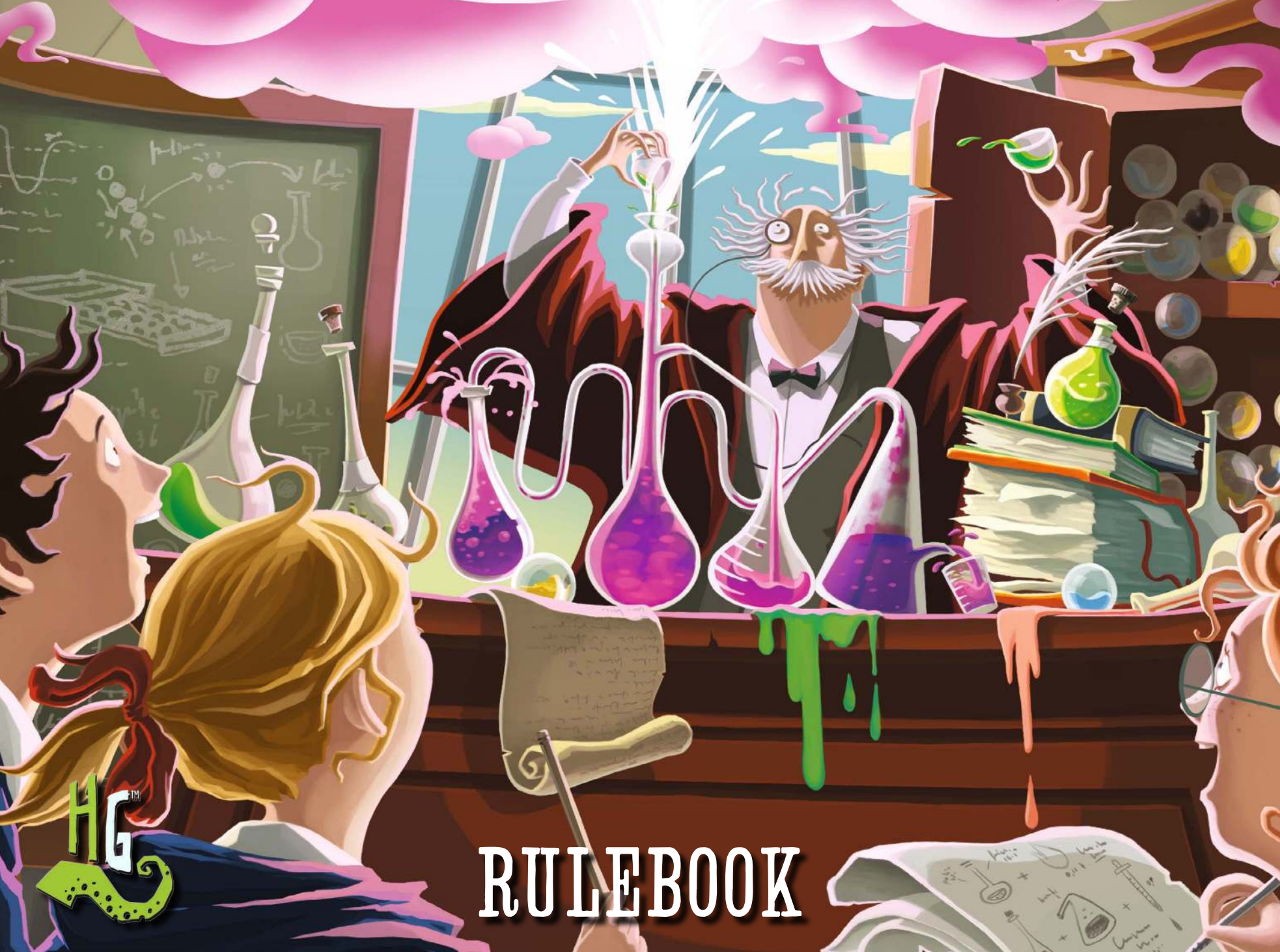

RULEBOOK

✧ INGREDIENT LEGEND ✧

(Futuris viempitivus)



UNICORN TEARS

Unicorn tears are the purest fluid known in the world of magic. Just use a few drops to catalyze very powerful magical effects.

Collecting unicorn tears is very easy! They are always depressed. Find one, make fun of his horn, and prepare for the shower. Bring a huge barrel.



DRAGON SMOKE

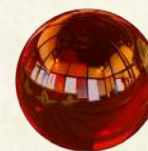

The toxic fumes exhaled by these dreadful reptiles are often used for their high magical reactivity. Beware, never, ever inhale them!

To obtain a dragon's smoke, poke its nose until it gets really, really angry. Collect the smoke with a flask. Run before he incinerates you.



OGRE MUCUS

This extremely viscous substance is used to thicken compounds otherwise too volatile. Always use a mask when you handle it.

Swamp ogres often take a cold. Go to a marsh. Bring a big box of paper tissue. Follow the sneezing. Not recommended for the faint of stomach.



FAIRY DANDRUFF



A very powerful ingredient. Also used by naughty children who refuse to grow up, to kidnap other kids and lead them astray.

Catch a fairy and gently brush its hair with a small comb. Avoid happy thoughts, or you may find yourself smashing through the ceiling in no time.

POTION EXPLOSION

A game of potion-crafting and marble-crashing for 2 to 4 sorcery students

RULEBOOK

(Explanatio regularii)

Dear students,

It's that time of the year.

Your last year at the Horribilorum Sorcery Academy for Witty Witches and Wizards is almost over, and it's time for the final exams!

As always, the rules are the same: Take the Ingredients from the Dispenser in the Potions Lab to complete your Potions. Keep in mind that the explosions you may trigger can be useful! The use of Potions you brew during this exam is not only allowed, but encouraged! Use them wisely to do a quicker and better job, and it will prove your worth as a soon-to-be witch or wizard.

When enough Skill Tokens have been awarded, the exam will end. Remember, though, that in order to win the Student of the Year Award, you'll need to be the one who brewed the most difficult (and valuable) potions!

Good luck!

COMPONENTS

1 Dispenser
(in several parts,
to be assembled)

80 Ingredient marbles
(in 4 colors, 20 marbles
of each color; a small bag with
some replacement marbles is
included, in case of defective ones)



15 Skill tokens



64 Potion tiles of 8 kinds
(Potions of the same kind have
the same power icon)

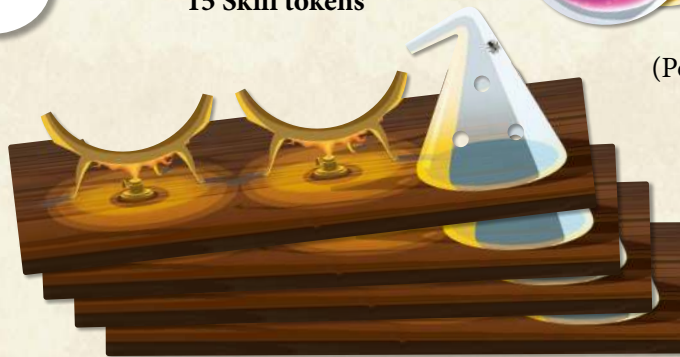

4 Desk boards



21 Little Help tokens



1 First Player token

Albedus Humblescore
Headmaster of the Horribilorum Sorcery Academy

☼ THE GAME IN A NUTSHELL ☼

(De horribilibus gamesibus, quickitur)

To brew your **Potions**, take **one Ingredient marble** from the **Dispenser** each turn, and make Ingredients of the same color **collide** to make them **explode** (and take them too)! The **bigger the explosions**, the **faster you'll brew your potions!**

Each Potion recipe may need **between 4 and 7 Ingredients**. They are represented by the holes on the Potion tiles themselves. Put the marbles **of the correct color** on your Potion tiles: when all the holes have been filled with a marble of the corresponding color, the Potion is completed.

Each Potion is **worth a certain number of points**, which depends on the **number of Ingredients** needed to complete it and the **strength of the magical power** it grants.

When a player completes **3 Potions with the same power**, or **5 Potions with 5 different powers**, they receive a **Skill token**, which is worth **4 points**.

When the required number of Skill tokens have been awarded, the end of the game is triggered.

The player with the most points is the winner.

☼ A ONE-TIME DO-IT-YOURSELF EXPERIENCE ☼

(Assemblatio Dispenserium ikeae)

Carefully remove the Dispenser parts from the punchboards. Then, assemble the Dispenser as shown in the diagrams below.

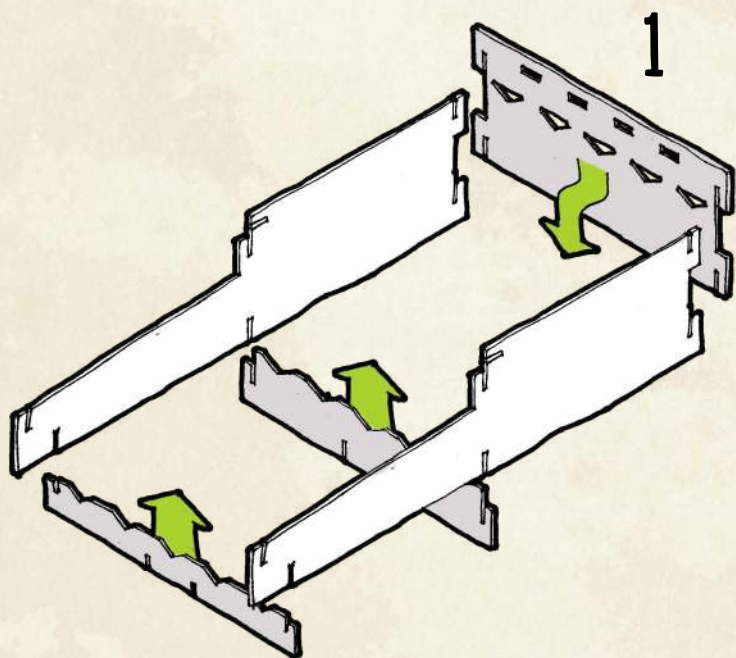

This fine-tuned procedure is the fruit of centuries of careful craft and scrupulous planning by my predecessors... and this very Professor of yours! I humbly pride myself on those nice arc-shaped marble gates. Aren't they beautiful?

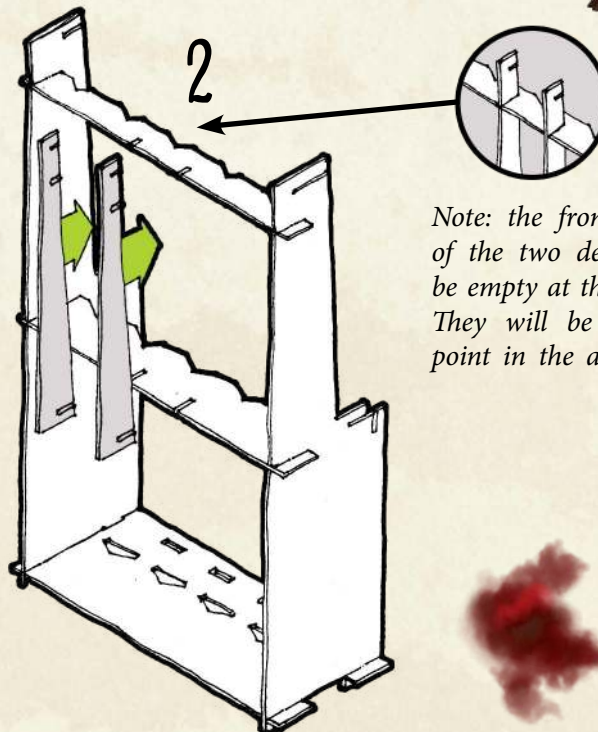

Note: the frontmost insert cuts of the two depicted pieces will be empty at the end of this step. They will be used at a later point in the assembling process.



*Once assembled, the Dispenser will nicely fit in your **Potion Explosion™** box. Thus, you won't need to disassemble it, ever. How convenient! You're welcome.*



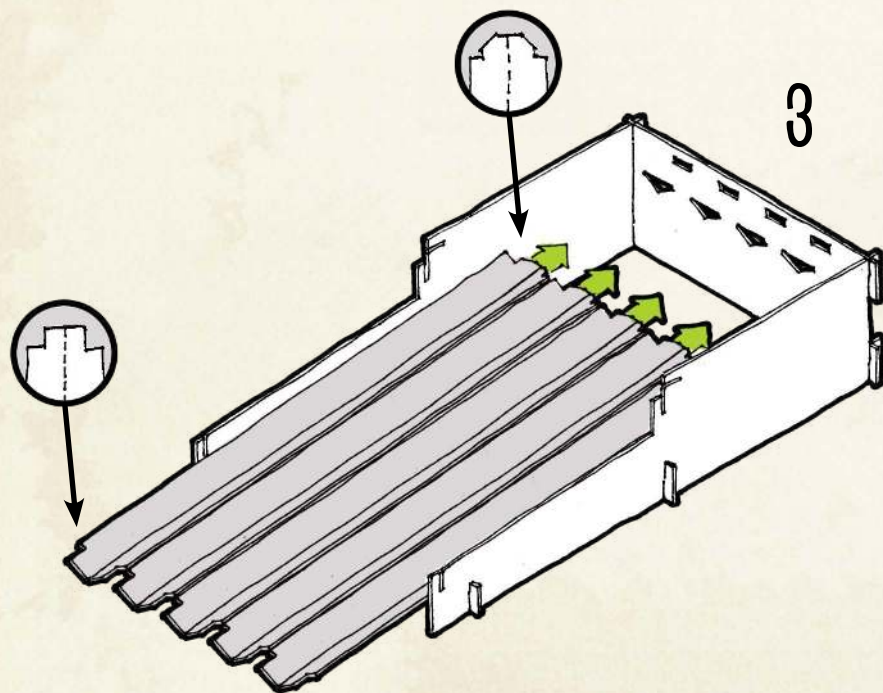

I'd point out that the bottom side of the slide is the one painted in black, and that the top side is the one with the wood texture, but it would be an insult to your intelligence, wouldn't it?



Note: When you bend the slide pieces, make sure to bend them very well. If you don't, the marbles may run out of the slide tracks during the game. You can then give them the correct angle and insert them into the back wall.

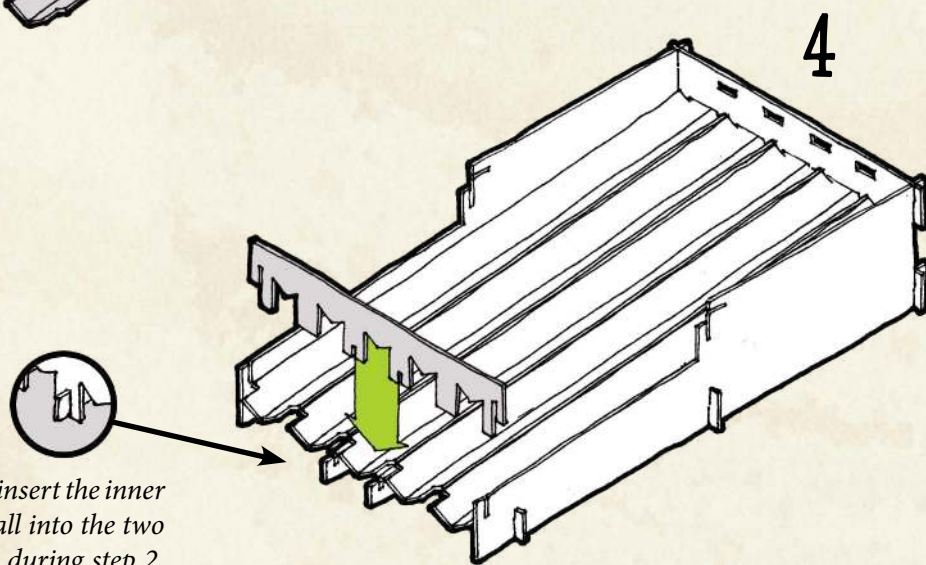

Note: make sure to insert the inner tabs of the front wall into the two insert cuts left free during step 2.

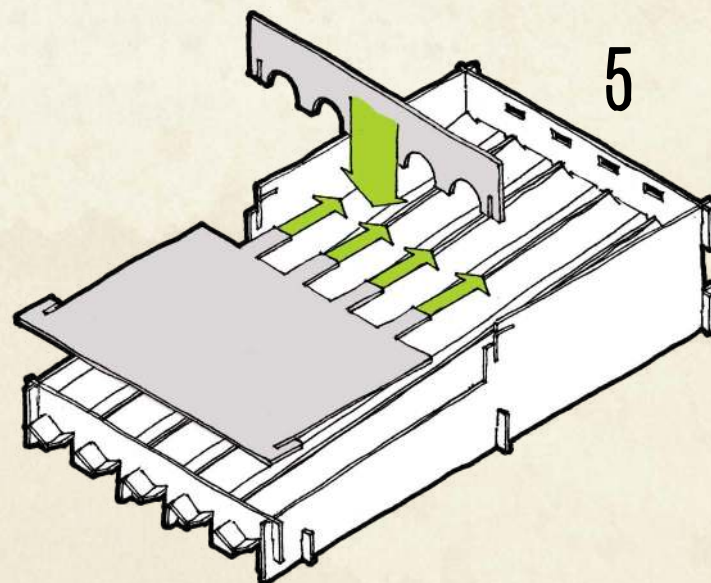

At the cost of being offensive towards the least differently-smart among you, again: the roof has to be inserted before the arc wall, obviously. But I'm sure you already figured it out by yourselves.

* GAME SETUP *

(Preparatio gameus)

1. Each player receives a **Desk board** and places it in front of himself, leaving some space both above and below it.
2. The player that most recently prepared a drink is the first player and takes the **First Player token**. This is just a reminder: it won't change during the game. Players play in turns, in clockwise order.
3. Take all the **Potion tiles** and remove 2 of the 8 different **kinds** of Potions, either randomly or by choice, and put them back into the box (they won't be used during the game).

For your first few games, I suggest you to leave out the Balm of Uttermost Stickiness and Filter of Lavamancing potions. Only the most talented potion brewers possess the necessary expertise to handle them!



4. From the 6 remaining kinds of Potion tiles, take 2 random **starter Potion tiles** (marked with the symbol ★) per player, and lay them out in the middle of the table, with the Recipe side (the one with the grey ribbon) facing up. Starting from the First Player and proceeding **clockwise**, each player takes **one** Starter Potion tile. Once all players have taken 1 Potion tile, each player takes a **second** Starter Potion tile, starting with the *last* player and proceeding **counterclockwise**.
5. Each player places their 2 starter Potion tiles, with their Recipe side up, on the two Bunsen burners of their Desk. This will be their **Brewing area**.
6. Once all the players have chosen their Starter Potion tiles, shuffle the remaining tiles together and divide them into 5 stacks, with the **Recipe side facing up**.
7. Put all the **Ingredient marbles** in the “tank” of the **Dispenser**, and make sure they roll down to completely fill the 5 tracks of the slide (see *Refilling the Dispenser*, page 9).
8. Place all the **Little Help tokens** and the **Skill tokens** near the Dispenser. Put some of the Skill tokens in a “**countdown**” stack (see *End of Game*, page 10). The number of Skill tokens to be put in this stack depends on the number of players (see the following table):

Number of players	“Countdown” stack
2	4 Skill tokens
3	5 Skill tokens
4	6 Skill tokens

You're ready to go!



Hi, I am the professor. I talk a lot. What I say is generally useful though. so maybe read it. okay?

☀ GAME TURN ☀ *(Turn's explanatio)*

A game of **Potion Explosion™** is played in turns. Players take turns in **clockwise order**. During your turn, you **MUST choose and take 1 Ingredient marble from the Dispenser**. This may trigger **one or more Explosions**. In addition, at any point during your turn, you **MAY drink one or more of your completed Potions AND/OR ask for a Little Help from the Professor**.

TAKING INGREDIENTS *(Ingredientorum pick)*

As described above, to take an Ingredient from the Dispenser, you simply have to choose and take one. You can freely choose any marble that is visible on the Dispenser, except for the 9th marble on each slide track (see the diagram to the left). **This is your regular pick for the turn.**

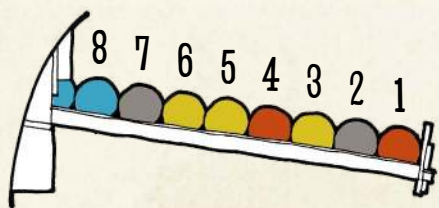

TRIGGERING AN EXPLOSION *(Causatio boom boom)*

As you can easily imagine, when an Ingredient marble is removed from the slide, all the marbles above it will roll down to fill the gap. This is when an **Explosion** can occur!

If two Ingredient marbles of the **same color collide**, they **explode**. When two Ingredients explode, **all of the Ingredients of that color connected to them** also explode. You take all of the exploding Ingredients, just like the one you directly picked from the Dispenser.

Not all students notice this at once: when there are three or more connected marbles of the same color, if you pick one of those from the middle, you still trigger an Explosion by making the others collide! That's a pretty neat move, don't you think?



If, after removing all of the exploding Ingredients, there is another collision between marbles of the same color, this new collision will trigger another Explosion, and you also take all of those exploding Ingredients. If, after that, another collision between marbles of the same color occurs, a third Explosion will happen, etc. (see the example to the left).

Note that those two blue Ingredient marbles in the last step of the example—even though involved in a collision—do not explode. An Explosion occurs only when two or more marbles of the same color collide with each other. Moreover, if you trigger a particularly big chain of Explosions, one or more slide tracks can end up being partially empty. This is not a problem.



The red marble is taken and starts a chain reaction.

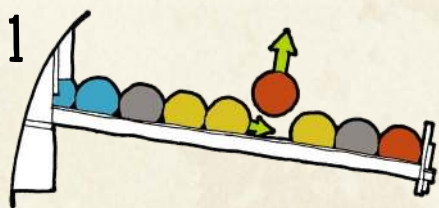

The three yellow marbles collide (and explode). They are all taken.

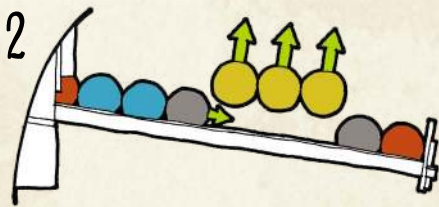

Next, the two black marbles collide and explode. They are also taken.



No more marbles of the same colour collide. The chain reaction stops.

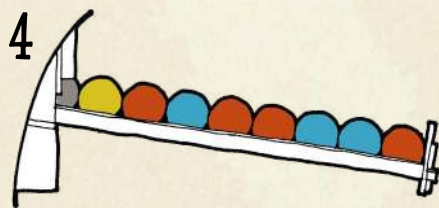

WITH A LITTLE HELP FROM THE PROFESSOR

(Professorum helpus capiendum est)

At any point during your turn (and only once per turn), before or after your regular pick, you **MAY** ask for a **Little Help from the Professor**—i.e. take a **Little Help token** and **1 Ingredient marble** of your choice from the Dispenser.

When you take an Ingredient marble using the Little Help from the professor, you **cannot trigger an Explosion**, even if you make 2 marbles of the same color collide.

For each Little Help token you **lose 2 points** at the end of the game.



A Little Help token

It's better to ask for my Little Help before you take your regular pick for the turn. If you do it wisely, you can create the perfect conditions to trigger huge chain reactions!!!



USING THE INGREDIENTS

(Usando marbles ad victoriam)

After taking Ingredients, either with your **regular pick**, a **Little Help from the professor**, or by **drinking a Potion** (see *Drinking Potions*, page 9), you will have a number of marbles in hand. To use them, you have the following options:

- * First, you **must** place any Ingredients in your hand on the matching empty holes of the same color on any Potion tiles brewing on your Desk, if possible (a yellow marble goes on a yellow hole, etc.). Once an Ingredient has been placed on a Potion tile, it **cannot be moved** until the Potion is complete.
- * If you have Ingredient marbles in hand that you cannot place on any Potion tile in your Brewing area, you **must** place those Ingredients in the small retort flask on your Desk. This is called your **Ingredient Pool**. During your turn, you may freely move Ingredients between your Pool and your hand.

The Ingredient Pool can only hold **up to 3 Ingredients** at a time. You can only hold Ingredients in your hand **until the end of your turn** (see *End of Turn*, page 9).

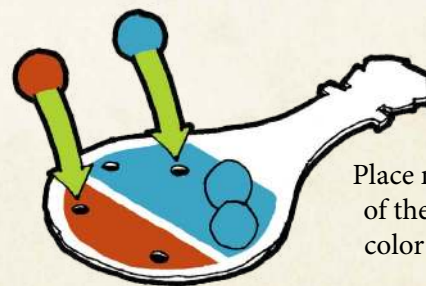

Place marbles on holes of the corresponding color on your Potion

Example: Heiko has 7 marbles in his hand: 4 red and 3 black. He has 2 blue marbles in his Pool left from his last turn. He places the 4 red marbles and 1 blue marble taken from his Pool on the Potions on his Desk. He wants to keep all the black marbles, so he takes the other blue marble from his Pool back into his hand and places the 3 black marbles into his Pool. Then he ends his turn, and discards the blue marble back into the Dispenser.



It goes without saying that, after you end your turn, you won't be able to move Ingredients out of your Pool until your next turn starts.

COMPLETING A POTION

(Completius potionibus)

When all of the holes of a Potion tile have been filled with Ingredients, that Potion has been **completed**. Put all of the marbles from the Potion back into the Dispenser (see *Refilling the Dispenser*, page 9), then flip the Potion tile from its front (the Recipe side) to its back (the Completed side) and move it in the area below your Desk. This is your **Potion area**.

Potions are **worth a certain number of points** at the end of the game (as shown on the tile itself), and they can also be drunk to activate special one-time magical effects (see *Drinking Potions*, page 9).

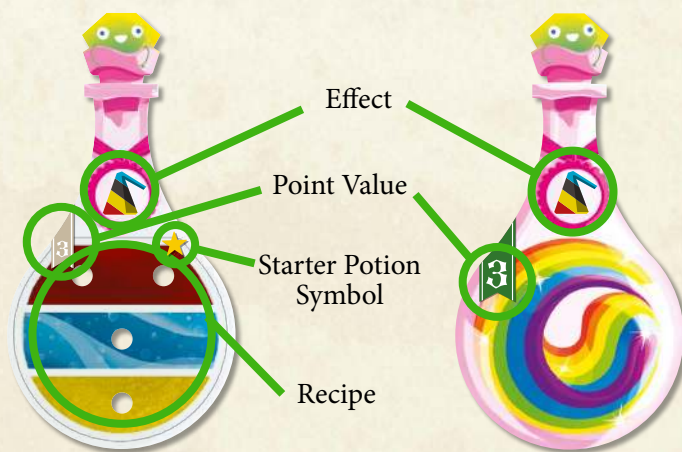

A potion, front or Recipe side

The same potion, back or Completed side

A Completed
potion



The same
potion, after
drinking it.

You can also drink Potions as soon as you complete them, if you wish. This exam aims to prove your worth as witches and wizards, not to merely test your theoretical knowledge of potions. Being able to make good use of the fruit of your labor and turn it to your advantage is a critical skill!

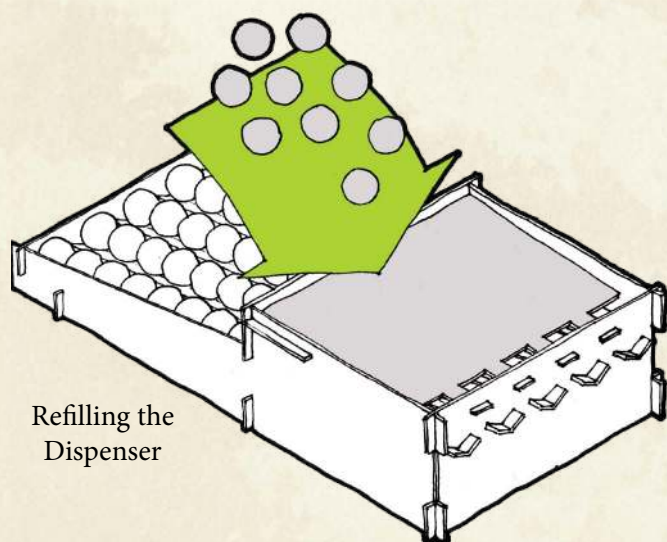

Refilling the
Dispenser



You will always have 2 Potion tiles in the Brewing area of your Desk at the beginning of each turn, and you won't be able to complete more than 2 Potions in a single turn. Hab!

DRINKING POTIONS

(Gulperere potionibus)

At any time during your turn, you may drink one or more of the Potions you have completed to activate their magical effects. Each Potion is a **one-use special power**: once a Potion has been drunk, it can't be drunk again.

To show that a Potion was used, just rotate it upside-down. Then, you can apply its effects.

When you use a Potion to take marbles from the Dispenser, you **never trigger Explosions**—Explosions can **only** be triggered when you use your **regular pick** for the turn. In the same way, you don't trigger Explosions when you use a Little Help from the professor.

Using a Potion does **not** make you lose the Potion tile: it still counts as a complete Potion, and it's still worth the same number of points at the end of the game.

REFILLING THE DISPENSER

(Dispenserium refillatus)

When you have to put Ingredient marbles into the Dispenser, you have to follow a couple little rules:

- * **Randomly roll the marbles onto the lid:** Do **not** try to direct them to the entrance hole of any specific slide track.
- * **Fill all the slide tracks whenever possible:** If one or more of the marbles end up laying on top of another marble (i.e. the track they ended up going into is already full, and they stick out from the lid), **move them into the entrance hole of the nearest slide track with empty space.**

END OF TURN

(Endius Turnum)

After you have taken your regular pick for the turn, you asked for the Little Help from the professor if you wanted to, and you have drunk all the Potions you intended to, **your turn ends**; follow these steps, in order:

- * If you still have marbles in your hand and your Ingredient Pool is already full, you **must** discard them back into the tank of the Dispenser.
- * If you have less than 2 Potion tiles in your Brewing area, you must **choose and draw** new Potions **from the top of any** of the five stacks available and place them on your Bunsen burners. **Note:** you **may not move Ingredients from your pool to the Potion tiles you just drew**, because you already finished your turn.
- * Check to see if you earned one or more **Skill tokens** (see *Skill tokens*, page 10).
- * Check to see if the **game end** has been triggered (see *End of Game*, page 10).

☀ SKILL TOKENS ☀

(Achievius rewardus)

Skill tokens are special rewards for students who prove themselves particularly talented... either by mastering one specific Potion, or for being able to brew a lot of different ones!

Whenever a player completes **the 3rd Potion of one same kind** (i.e., with the same power) and/or **the 5th different kind of Potion** (i.e., completing Potions with 5 different powers), that player automatically receives a Skill token **from the “countdown” stack** (or from the general pool if the “countdown” stack is empty). Each Skill token is worth 4 points at the end of the game.



A Skill token

I should not have to point this out, but... better safe than sorry: you don't have to “create sets of Potion tiles” and “spend” them to receive Skill tokens. In the moment you complete a 3rd Potion of one same kind, you receive a token. In the moment you complete a 5th kind of Potion, you receive a token. That's it.



Number of players	“Countdown” stack
2	4 Skill tokens
3	5 Skill tokens
4	6 Skill tokens

We suggest these numbers of Skill tokens so that your games last a reasonable amount of time (not too short, not too long). But, if you have particularly slow or overthinking players at the table, or if you feel confident enough with the basics of the game, feel free to agree on a different number at the beginning of play, if you'd like to have shorter or longer games!



Example: It's a 4-player game. Heiko was the first player at the beginning of the game, and just finished his turn after taking the 5th Skill token from the “countdown” stack—his second—leaving one Skill token in the stack. Now it's David's turn. He manages to earn the last Skill token from the “countdown” stack, which triggers the end of the game. Jose and Anna will both have one final turn to play, then the game will end. Jose plays next, but does not earn any Skill token on his turn. During her turn, Anna manages to get 1 Skill token for “The 3rd Potion of one same kind”, and another for “The 5th different kind of Potion”. Since the “countdown” stack is empty, she takes them from the general pool. At the end of Anna's turn, the game is over. The players can finally calculate their final scores.

☀ END OF GAME ☀

(Calculatio finalis pointibus)

During the game setup, you placed a certain number of Skill tokens into a **“countdown” stack** (see table to the right). If, at the end of any player's turn, the **last of the Skill tokens** from the “countdown” stack **has been taken**, the **end of the game is triggered**. The end of the game is **also triggered** if, at the end of any player's round, there are **no more Potion tiles** available.

The game continues, in clockwise order, until the player to the **right** of the First Player completes their next turn (so that all players will have played the same number of turns during the game). Even if the required number of Skill tokens have already been awarded, **players can still earn more from the general pool**, if they are able to do so.

After this, all players add up the points they obtained from all the Potion tiles they completed and the Skill tokens they collected, then subtract 2 points for each Little Help token they have.

The player with the most points is the winner!

In case of a tie, all the tied players (starting from the First Player, in turn order) each take one marble from the Dispenser to try to trigger an Explosion. The player who takes the *most* marbles in this way is the winner.



www.horrible-games.com
info@horrible-games.com

If you have any issues, please contact us at:
customercare@horrible-games.com

* HOW TO TIDILY FIT EVERYTHING INTO THE GAME BOX *

(Avoidius horribilis messibus)

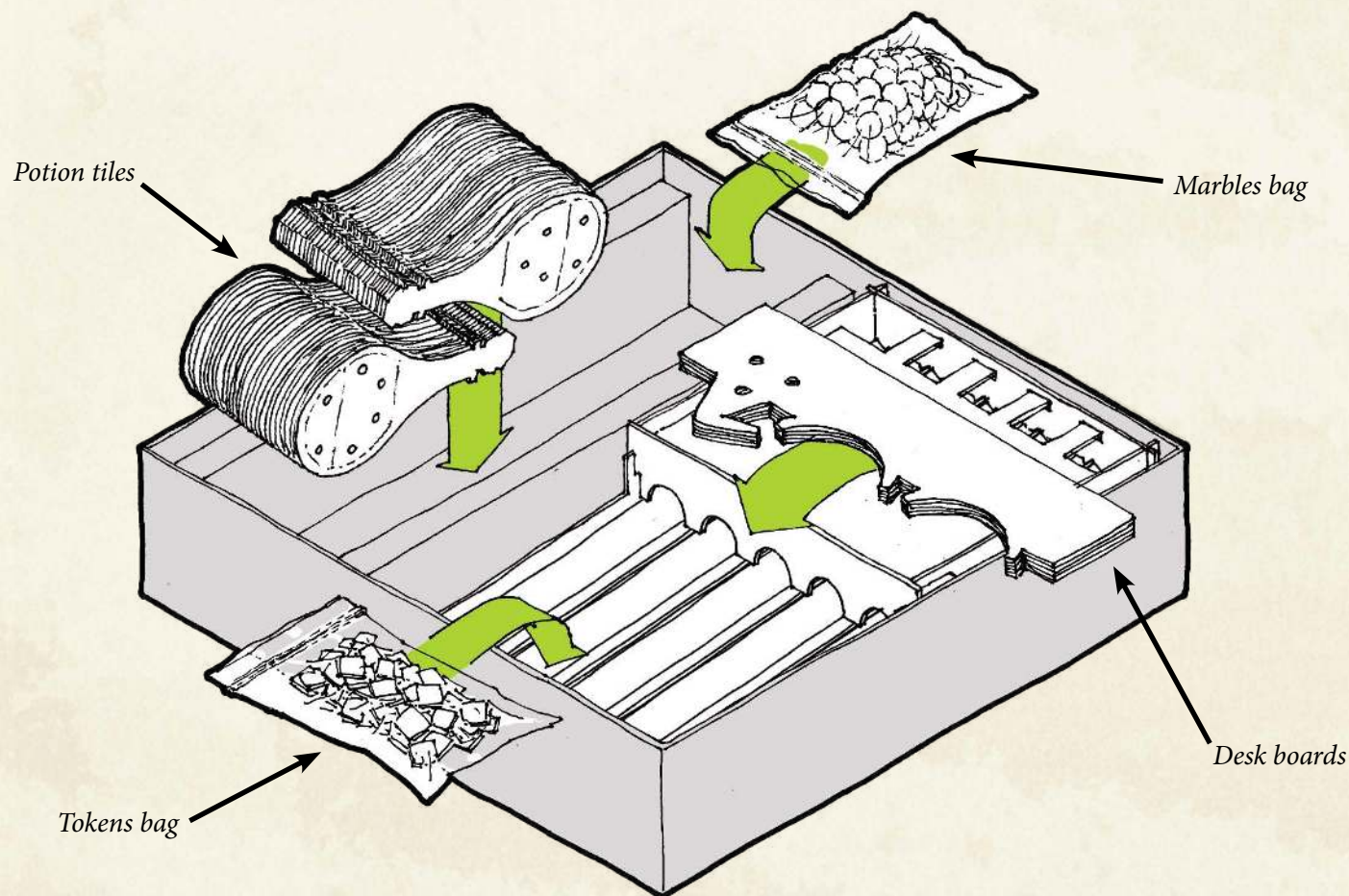

* CREDITS *

(Riconoscentium laboribus)

Design: Lorenzo Silva, Andrea Crespi & Stefano Castelli

Artwork: Giulia Ghigini

Graphic Design: Heiko Günther

Art Direction: Lorenzo Silva

Development: Andrea Crespi & Lorenzo Silva

Project Manager: Alessandro Prà

Production Manager: Lorenzo Silva

English Language Rules: Alessandro Prà & William Niebling

Special Thanks: Albedus Humblescore, Harry P., Gemblo, Bomberman, Silvia Proverbio, Michelle Crespi, Valentina Adduci, Heiko Eller, Harald Bilz, Noa Vassalli, Luca Ricci, Franchino Quintigliano, Marco Brera, Giulia De Florio, Lucio Brera, Pietro Righi Riva, Alessandro Fibbi, Alessia Pastore, Paolo Pulci, David Preti, Daniele Tascini, Giuliano Acquati, Eleonora Del Bono, Michele Silva, Alizarina Silva, Diego 3D, Diego Cerreti, Giovanni Intini, Riccardo Sandroni, Maurizio Vergendo, Max Tolazzi, Michael Kröhnert, Alessio Vallese, Federico Latini, Paolo Mori, Martino Chiacchiera, Walter Nuccio, Roberto Pestrin, Giuseppe Lapadula, Elena Appiani, Venturelli Emiliano, Andrea Mezzotero, Gabriele Bubola, Sara Rubino, Ciro Faccioli, Gabriele Golfarini, Alice Caroti, Antonella Frezza, Francesca Mazzei, Enrico Procacci, Massimiliano Calimera, Gianfranco Castelli, Francesca Mazzotta, Giulia Marucci, Massimo Giovacchini, Alessandra Tuzi, Susan Micale, Isabella Bisiacchi, Francesco Diodato, Flavio Franzone, Edoardo Chiesa, Andrea Greco, Francesco Granone, Roberta Signorello, Luca Pinchiroli, Valentina Foglietto, Giovanni Tagliati, Roberto Vicario, Claudia Crespi, Roberto Carugo, Maurizio Carugo, Davide Calza, Andrea Polimadei, Andrea Settoni, Giuseppe Cicero, Stefano Proverbio, Angelo Raimondi, Andrea Marinetti, Valentina Sacchi, Alessandro Adduci, Annachiara Ogliari, Alessandro Capponi, Sara Tonetti, Mauro Marinetti, Alfredo Genovese, Ari Emdin, Anna Scovenna *and many many others!*



☼ LIST OF POTION EFFECTS ☼

(De potionis effectibus)



POTION OF WISDOM



Take one Ingredient of your choice from the Dispenser. No Explosions are triggered.

Nothing's out of reach if you think it through.



ELIXIR OF BLIND LOVE

Steal all the Ingredients from 1 opponent's Pool.

Why bother with theft, when all you need to do is unleash your dazzling charm?

POTION OF MAGNETICAL ATTRACTION



Take 2 adjacent Ingredients of different colors from the same slide track of the Dispenser. No Explosions are triggered.

I don't think this is what they mean when they say "magnetic personality".



POTION OF PRISMATIC JOY

You can place all Ingredients in your Pool on any holes of your incomplete Potions, regardless of their color.

Marbles? Colors? Who cares... let's party!

ABYSSAL DRAFT



Take up to 1 Ingredient of each color from the bottom row of the Dispenser slide tracks. You can only take 1 Ingredient from each slide track.

This is what is called "scraping the bottom of the barrel". A huge barrel.



SANDS OF TIME

Activate again the effect of 1 Potion you already used.

We can always learn from our past mistakes... but we can gain even more from our past good moves!

BALM OF UTTERMOST STICKINESS

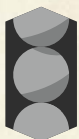

Take 2 or more adjacent Ingredients of the same color from the same slide track of the Dispenser. No Explosions are triggered.

*This stuff is stickier than molasses!
The thing is... how do you unstick this mess?*

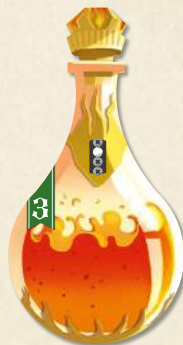

FILTER OF LAVAMANCING

Discard up to 5 Ingredients of 1 color from the same slide track of the Dispenser back into the tank. No Explosions are triggered.

Not exactly a surgical strike type of thing, but undeniably powerful.