

HJALMAR HACH & LORENZO SILVA

RAILROAD™

ink

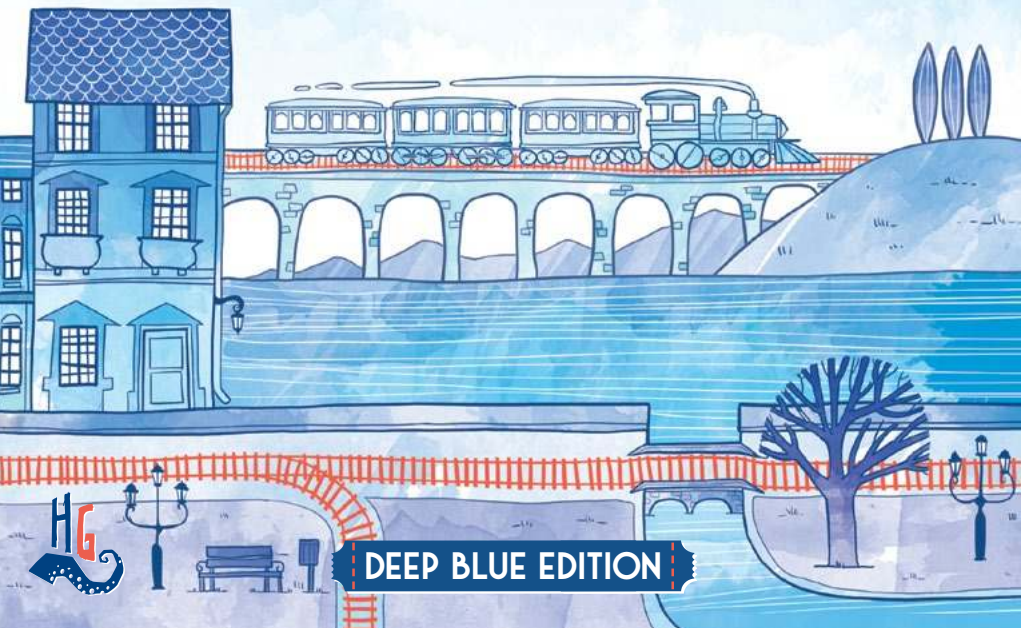

DEEP BLUE EDITION

COMPONENTS

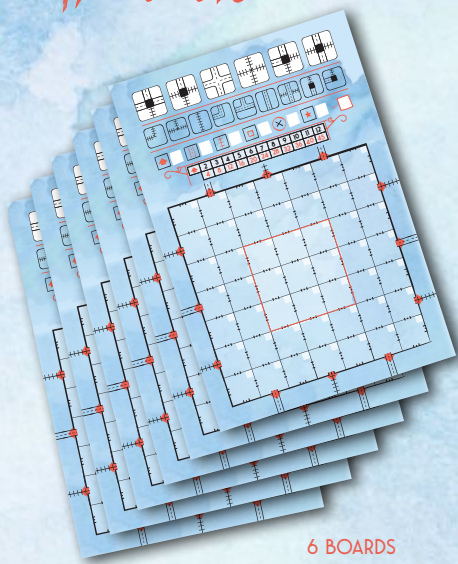

6 BOARDS



6 MARKERS



4 ROUTE DICE



2 RIVER DICE



2 LAKE DICE

GAME OVERVIEW

A game of **Railroad Ink™** is played over **7 rounds**. The goal is to **connect** as many **Exits** ▲ to each other as possible by **drawing Routes** that can create **Networks**. The more Exits ▲ you connect to the **same Network**, the more **points** it will be worth. **Bonus points** can be earned for your **Longest Railway**, your **Longest Highway**, and by drawing on the **Central Spaces** of your Board.

SETUP

1. Each player takes a **Board** and places it in front of them.
2. Each player also takes a **marker**.
3. Place the **Route dice** in the middle of the table.
4. The **River and Lake dice** are only used in the Expansions (see page 10).

SPECIAL ROUTES

ROUTE DICE REFERENCE

SCORING TABLE

NETWORK VALUES

CENTRAL SPACES

EXITS



3

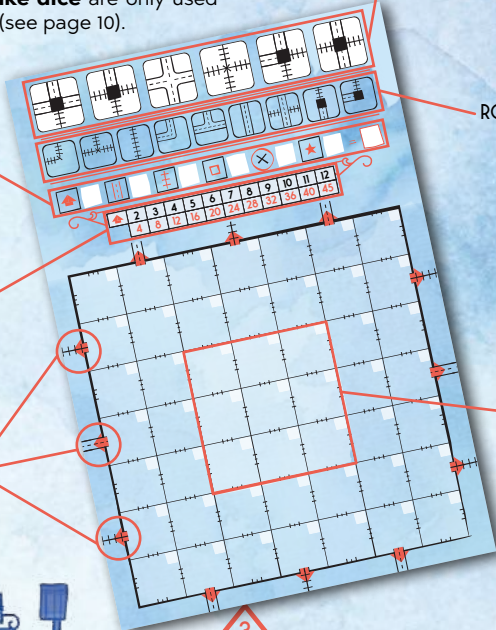

GAME ROUNDS

At the beginning of each round, the **Route dice** are rolled **once**. The results of the roll will determine which **Routes** all players **must draw** that round. After the roll, all players play **simultaneously**, drawing the Routes rolled on their own boards.

ROLLING DICE

Take the Route dice and **roll them** in the middle of the table. Place the dice so they are **easily visible** to all players.

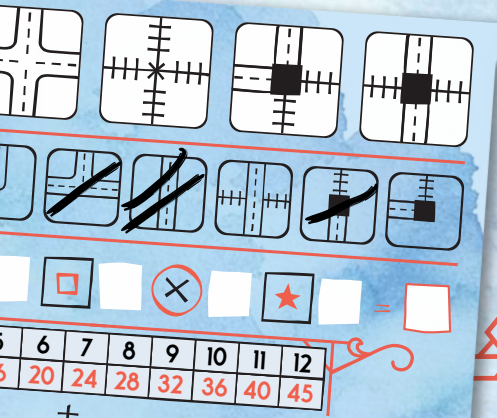

There are 2 kinds of Route dice.

3 dice show these 6 kinds of Routes:



Straight Highway



Straight Railway



Curved Highway



Curved Railway



T-junction Highway



T-junction Railway



1 die shows these 3 kinds of Routes:



Overpass



Straight Station



Curved Station

Note: **Stations** allow you to **connect** a Railway Route to a Highway Route. **Overpasses** allow the two to cross **without being connected** to each other.



Hint: To more easily keep track of the Routes you have to draw, you can use the **dice reference** on your board to **mark the available Routes**, if you so desire.

DRAWING ROUTES

After the dice roll, all players must draw the **Routes** on their boards **at the same time**.

There are a few **drawing rules** you need to follow:

1. Each Route you draw must be **connected** by **at least one side** to either one of the **Exits**  or a preexisting Route. If you **can't connect** a Route, you can't draw it.
2. You **must** draw **all 4** Routes shown on the dice each round (if possible, and each Route showing can only be drawn **once**, of course).
3. You **can't draw** Routes in a way that **directly connects** Railways to Highways or vice versa (you need a **Station** to do that).

Important: When drawing Routes, you can freely **rotate** and/or **reverse** the pattern you see on the die.

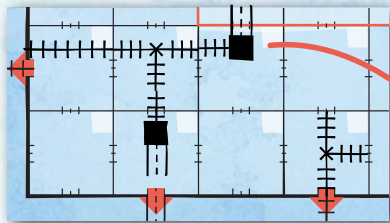
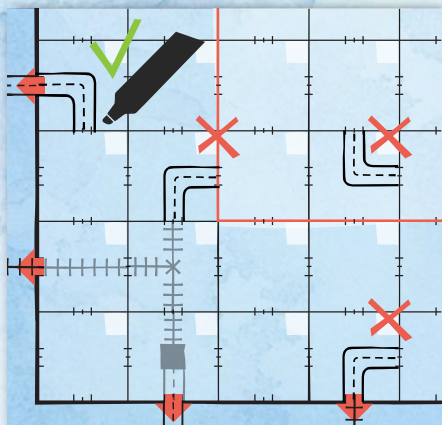

USING SPECIAL ROUTES

Each player can also use **6 Special Routes**, displayed in the **top part of the boards**, that **do not appear** on the Route dice. These Routes may allow you to **connect different Networks** together and/or make bigger Networks.

You may draw a Special Route **once per round**, in addition to the Routes shown on the Route dice, but you may use each Special Route only **once per game**. After you use a Special Route, you must **mark it off** on your board as a reminder that you can't use it again.

Also, you can only use **up to 3** Special Routes during the entire game (and remember, only **1 per round**).

END OF THE ROUND

Once all the players have drawn all of the available **Routes**, the round ends.

Each player must **mark the spaces** where they drew Routes this round by writing the **number of the current round** in the white boxes of each space they drew on. You can **never erase** the Routes you drew in a previous round.

After that, **roll** the Route Dice to start the **next round**.

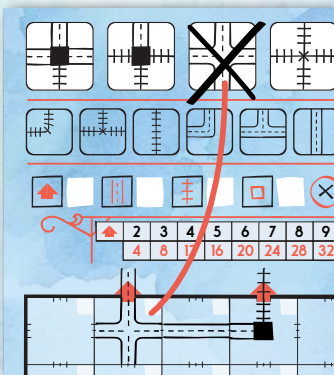

Remember: Only 1 Special Route per round, and only up to 3 per game!

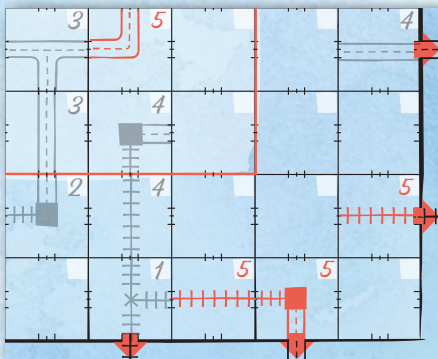

Example: The end of the 5th round.



END OF THE GAME

The game ends after the **7th round**. Now it's time to count your score! Each player counts the points they earned for their **connected Exits** ▲, their **Longest Railway** and **Longest Highway**, and the **Central Spaces** they drew on, **marking their points** on the designated spaces of the **Scoring Table** on their boards. For more details, see the next page.

Then, each player must check for **incomplete Routes**. Each **end** of a Route that **does not connect** with any other Route or the **outer edge** of the board counts as an Error. Mark each one of these Errors with this symbol: (⊗). You **lose 1 point** for each Error on your board. Mark these penalty points on the matching space of your Scoring Table.

Note: If you are playing with an Expansion ★ (see page 10), mark any additional points on the expansion space of your scoring board.

Finally, **add up** all the points you earned (**subtracting** any points from Errors) and write your total score on your Scoring Table. The player with the **most points** wins! In case of a tie, the winner is the player with the **fewest Error marks** on their board. If they're still tied, the victory is **shared**.



Scan the QR code to download a print-and-play game board!

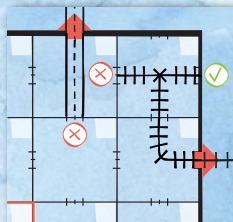

© 2018 Horrible Games.
All rights reserved.

CREDITS

Design:
Hjalmar Hach, Lorenzo Silva
Artwork:
Marta Tranquilli
Graphic Design:
Rita Ottolini, Noa Vassalli
Project Manager:
Lorenzo Silva
Production Manager:
Alessandro Pra'
Rulebook:
Alessandro Pra'
English Revision:
William Niebling

PARTNEREDITION

Publisher:
Graphic Design:
Production:
Proofreading:

www.horrible-games.com

HOW TO SCORE POINTS

CONNECTING EXITS ▲

Connecting Exits ▲ is the main way to score points in **Railroad Ink™**. At the **end of the game**, each **set of Exits** ▲ that are connected to each other via the same **Network of Routes** is worth a number of **points** determined by the **number of Exits** ▲ connected together, as shown on the **Network Values** on your Board.

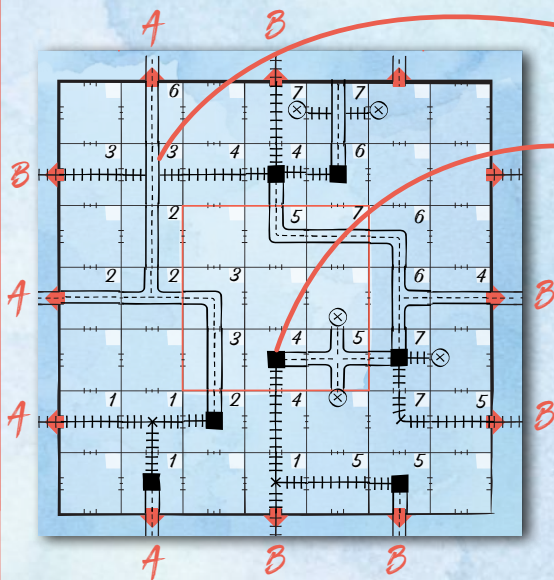

Note: Overpasses only allow you to make two of your **Networks cross each other**, but they don't create a connection between the two.

Note: You can use **Stations** to connect **Railway Routes** and **Highway Routes** to each other.





Network Values

▲	2	3	4	5	6	7	▲
	4	8	12	16	20	24	32

Example: Dagmar's board at the end of the game has 2 **Networks**. One (A) connects a total of 4 **Exits** and is worth 12 points. The other (B) connects 6 **Exits** and is worth 20 points. They score 32 points for their **Networks**!

BONUS POINTS

While the points you get for **connecting Exits**  may end up being the bulk of your score when you add up points at the end of the game, do not underestimate the importance of the **bonus points** you can earn from your **Longest Highway**, **Longest Railway**, and **Central Spaces**.

 Your **Longest Highway** is the **longest unbroken streak** of **adjacent spaces** where you drew **Highway Routes** that are **connected to each other** (not counting any loops or branches), such as the route marked in blue to the right. You **score 1 point for each space** that makes up your single longest Highway branch. Stations **do not interrupt** your Highway. This example shows a Longest Highway of 8 spaces.

 Your **Longest Railway** is determined the same way as the Longest Highway, only counting **Railway Routes** instead of Highway Routes, like the one marked in red to the right (worth 5 points).

 Your **Central Spaces** are the 9 spaces in the middle of your board. You score **1 point** for each **Central Space** you drew anything on.

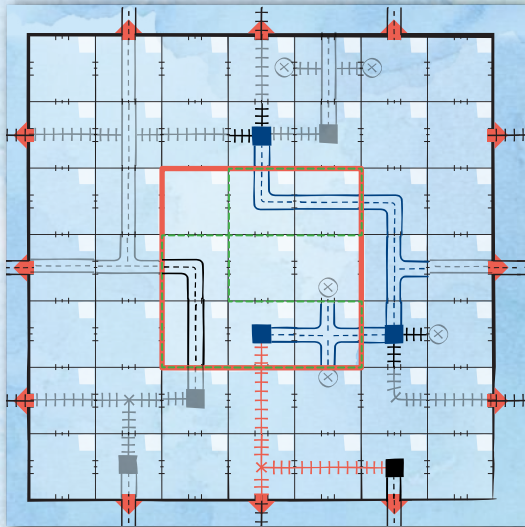
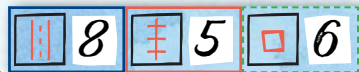

If you have two Longest Routes (with the same number of spaces), **only 1 counts** towards your final score.



EXPANSIONS ★

Once you feel confident enough with the ins and outs of **Railroad Ink™**, you can spice things up by using 1 of the 2 **optional Expansions** included in this box.

If you play with an expansion ★, you must roll **the respective Expansion dice** along with the 4 Route dice at the beginning of each round. In addition, the Expansion may change the **number of rounds** you must play and give you **new ways to score points**.

During the game, follow the **same rules** as the regular game with a few **changes**, as described on the following pages.

At the end of the game, when you **add up your score**, remember to count the points you earned from the **Expansion ★** you're using, and mark them in the designated space of your scoring table.

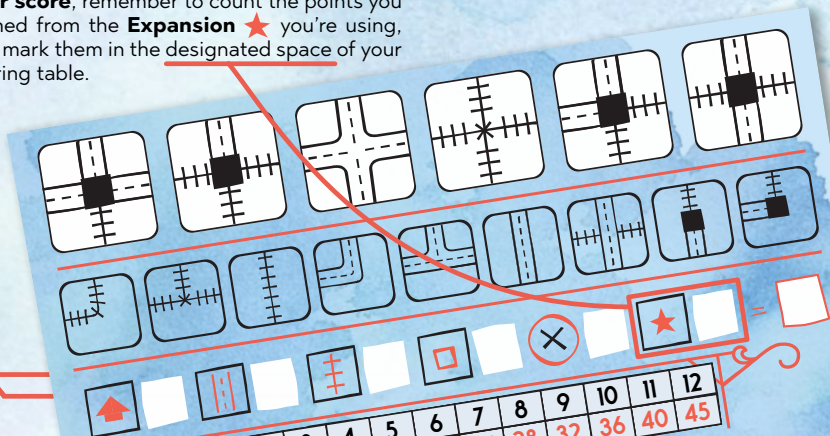

RIVER DICE

 6 ROUNDS

Rivers are a **third kind of Route**. Sort of. They can't be used to connect Exits, but they can be connected to each other to **create a River**. Rivers **can't be crossed** by Highways or Railways, unless a **Bridge face** on a River die allows you to do so. The additional goal is to make the **Longest River possible**. When playing with the **River Expansion** ★, apply these **changes** to the regular game rules:

- ◇ The game only lasts **6 rounds**.
- ◇ When you draw Routes, you **do not have** to draw **any** of the River dice if you don't want to (you still have to use all 4 Route dice).
- ◇ The Rivers you draw **don't have** to be **connected** to preexisting Routes and/or other Rivers.
- ◇ You **can't connect** River Routes with other kinds of Routes (nor Exits ▲).
- ◇ When checking for **Errors**, each end of a River that **does not connect** to another River or the outer edge of the Board **counts as an Error**.
- ◇ At the end of the game, choose 1 of your Rivers. You gain **1 point** for each **space** the River runs through. If **both ends** of the River are connected to the outer edge of the Board, you get **3 additional points**.

Example: Diana created 2 River Routes. The longest would be worth 7 points, but its ends are not connected to the edges of the Board. Instead, the shortest one is worth 8 points: 5 for its length plus 3 extra points for having both ends connected to the edges of the Board, so she chooses to score points for that River.



RIVER ROUTE FACES



BRIDGE FACES

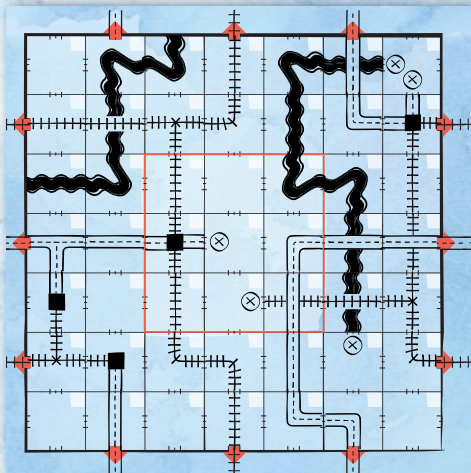

LAKE DICE

 : 6 ROUNDS

Lakes have **two advantages**. First of all, they allow you to create bigger Networks by connecting your Routes to a Lake with the **Pier faces** on the Lake dice. You also score **additional points** for the **Smallest Lake** on your Board. When playing with the **Lake expansion** ★, apply these **changes** to the regular game rules:

- ◇ The game only lasts for **6 rounds**.
- ◇ When you draw Routes, you **do not have** to draw **any** of the Lake dice, if you don't want to (you still have to use all 4 Route dice).
- ◇ The Lakes you draw **don't need** to be **connected** to pre-existing Routes and/or other Lakes.
- ◇ If a space has **3 sides** adjacent to the **open sides** of Lakes, it **must** be completely **filled with water** immediately.
- ◇ Open Lake sides **do not count** as Errors at the end of the game.
- ◇ Networks connected to the **same Lake** (by Piers) are also connected to **each other**.
- ◇ At the end of the game, you get **1 point** for each space occupied by your **Smallest Lake**.

Example: The bigger Lake would be worth 7 points, but since Harry also made a smaller one, he only gets 3 points. At the same time, the Smallest Lake allowed him to join two small Networks into a single one with 4 Exits, which is worth 12 points!

